

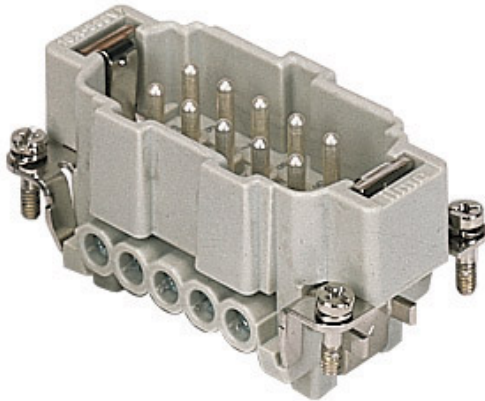



Part number

CNEM 10 T



Brief description:

male insert, 10 poles + PE, screw terminal connections, 16A, 500V, 6kV, 3, silver plated, size "57.27", CLASS insert series

Product description		Approvals / Standards	
Model	male insert	Reference standard	EN 61984 (2001-11)
Version	screw terminal connections	Quality mark	  DNV-GL, EAC
Series	CNE	Conformity	CQC, CE
Product type	with male contacts	General ordering information	
Variant	with plate	EAN13 code	8015747032919
Family	CLASS inserts	Tariff number	85369095
Size	size "57.27"	Country of origin	Made in EU (IT)
N. of poles	10 poles + 	ETIM classification	EC000438
Technical data		Packaging Information	
Current	16 A (A.C. and D.C.)	Packaging length	210,00 mm
Voltage	500 V	Packaging height	75,00 mm
Rated impulse withstand voltage	6kV	Packaging width	180,00 mm
Pollution degree	3	Packaging weight	2,31 kg
Wire cross-section	0,50 mm ² - 4,00 mm ²	Packaging volume	2,84 dm ³
AWG size	20 - 12	Packaging description	Carton box
Operating temperature range (min, max)	-40°C ... +125°C	Packaging quantity	30 Pcs
Contact type	silver plated	Packaging EAN code	8015747032926
Mating cycles	≥ 500	Sub-packaging length	67,00 mm
IP degree of protection	IP20 without enclosure; IP65/IP66/IP67/IP68 with enclosure	Sub-packaging height	36,00 mm
PE terminal stripping length	7 mm	Sub-packaging width	180,00 mm
PE wire cross-section	0,14 - 4 mm ² ; AWG 20 - 12	Sub-packaging weight	0,39 kg
Further technical details		Sub-packaging volume	0,43 dm ³
Characteristics according to EN 61984	16A 500V 6kV 3; 16A 400/690V 6kV 2	Sub-packaging description	Carton
Insulation resistance	≥ 10 GΩ	Sub-packaging quantity	5 Pcs
Rated voltage according to UL/CSA	600V	Sub-packaging EAN barcode	8015747032933
UL 94 flammability rating	V-0		
Weight	77,00 g		

Part number

CNEM 10 T



Catalogue drawings

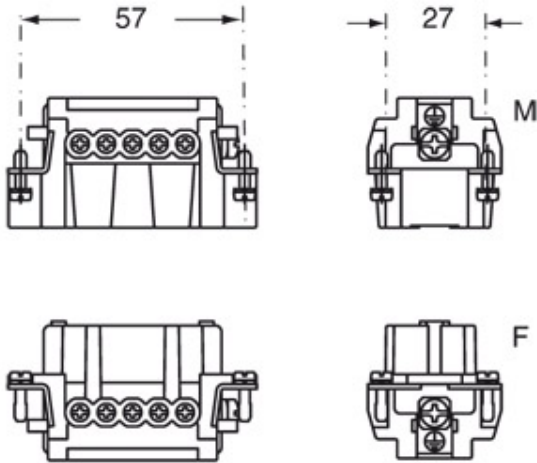

Catalogue drawings

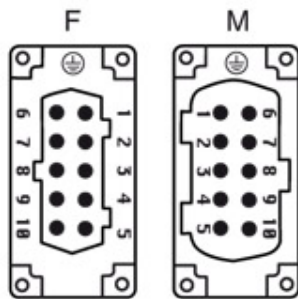
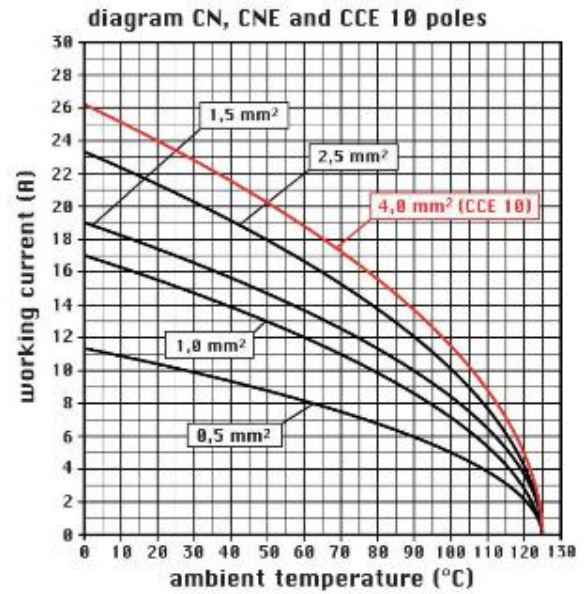

Notes

CNE ... : for non-prepared conductors

CNE ... X : for conductors with bush terminal

