

Part number

MHV 06 L20



Hood, C-TYPE series, with 2 pegs, M20 top cable entry, size "44.27"



Product description

Product type	Hood
Series	C-TYPE
Closing type	With 2 pegs
Size	Size 44.27
Cable entry	Top cable entry M20

Technical data

IP degree of protection	IP65 / IP66 / IP69
--------------------------------	--------------------

Further technical details

Weight	89,70 g
Operating temperature range (min, max)	-40°C...+125°C

Material properties

Colour	RAL 7040 grey
RoHs conformity	Compliant
China RoHs - EFUP	E
REACH SVHC substances	No

Approvals / Standards

Certifications	DNV, BV
UL	ECBT2
cUL	ECBT8

General ordering information

EAN13 code	8015747055352
eCl@ss 8.1	27440202
ETIM 7.0	EC000437

Packaging Information

Packaging length	270,00 mm
Packaging height	130,00 mm
Packaging width	135,00 mm
Packaging weight	1,93 kg
Packaging volume	4,74 dm ³
Packaging description	Carton box
Packaging quantity	20 Pcs
Packaging EAN code	8015747055369
Sub-packaging weight	0,48 kg
Sub-packaging description	Plastic packaging
Sub-packaging quantity	5 Pcs
Sub-packaging EAN barcode	8015747055376

Part number

MHV 06 L20



Catalogue drawings

CHO LX CHV LX - MHO LX MHV LX

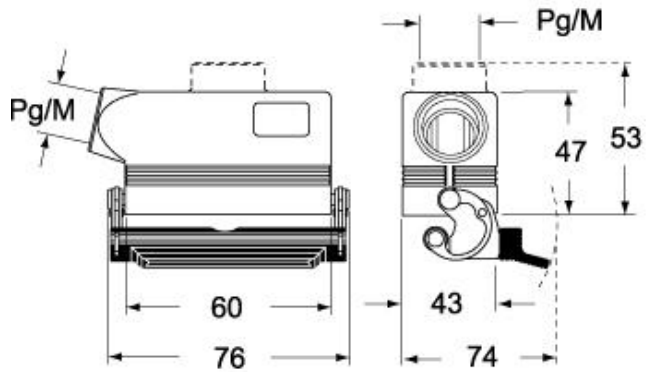

CHV LG (CAV LG), MHV LG (MAV LG) [MFV LG]



CHO L (CAO L) - MHO (MAO/MFO/MFV L) MHV L [MAV L]

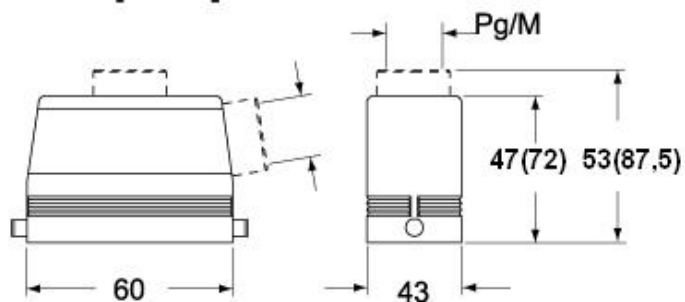

Notes

Dimensions shown in mm are not binding and may be changed without notice.