

## XUK0ARCTL2

photo-electric sensor - XUK - multi - Sn 0..30m -  
24..240VAC/DC - cable 2m



### Main

Range of product	OsiSense XU
Series name	General purpose multimode
Electronic sensor type	Photo-electric sensor
Sensor name	XUK
Sensor design	Compact 50 x 50
Detection system	Multimode
Material	Plastic
Type of output signal	Discrete
Supply circuit type	AC/DC
Wiring technique	5-wire
Discrete output function	1 NO or 1 NC programmable
Electrical connection	Cable
Cable length	2 m
Product specific application	-
Emission	Infrared diffuse Infrared diffuse with background suppression Infrared thru beam Red polarised reflex
[Sn] nominal sensing distance	0.28 m diffuse with background suppression 0.8 m diffuse 4 m polarised reflex need reflector XUZC50 30 m thru beam need a transmitter XUK0ARCTL2T

### Complementary

Enclosure material	PBT
Lens material	PMMA
Maximum sensing distance	35 m thru beam 0.28 m diffuse with background suppression 1.2 m diffuse 5.7 m polarised reflex
Output type	Relay
Add on output	Without, <= 50 mA with overload and short-circuit protection
Wire insulation material	PvR
Status LED	1 LED (green) for supply 1 LED (red) for instability 1 LED (yellow) for output state
[Us] rated supply voltage	24...240 V AC 24...240 V DC
Supply voltage limits	20...264 V AC 20...264 V DC
Switching capacity in mA	3 A (cos φ = 1 for 0.5 million cycles at 1 operating cycle per second at 250 V)
Switching frequency	<= 20 Hz
Voltage drop	<= 1.5 V (closed state)
Power consumption in W	3 W AC/DC
Time delay range	0...10 s monostable, on-delay or off-delay (programmable) delay
Delay first up	< 300 ms
Delay response	< 25 ms
Delay recovery	< 25 ms
Setting-up	Self-teaching
Electrical durability	500000 cycles, cos f = 1, 60 cyc/mn at 250 V

The information provided in this documentation contains general descriptions and/or technical characteristics of the performance of the products contained herein. This documentation is not intended as a substitute for and is not to be used for determining suitability or reliability of these products for specific user applications. It is the duty of any such user or integrator to perform the appropriate and complete risk analysis, evaluation and testing of the products with respect to the relevant specific application or use thereof. Neither Schneider Electric Industries SAS nor any of its affiliates or subsidiaries shall be responsible or liable for misuse of the information contained herein.

Depth	50 mm
Height	50 mm
Width	18 mm
Product weight	0.175 kg

## Environment

product certifications	CE CSA UL
ambient air temperature for operation	-25...55 °C
ambient air temperature for storage	-40...70 °C
vibration resistance	7 gn, amplitude = +/- 1.5 mm (f = 10...55 Hz) conforming to IEC 60068-2-6
shock resistance	30 gn (duration = 11 ms) conforming to IEC 60068-2-27
IP degree of protection	IP65 double insulation conforming to IEC 60529

## Offer Sustainability

Sustainable offer status	Not Green Premium product
RoHS (date code: YYWW)	Compliant - since 0903 - Schneider Electric declaration of conformity
REACH	Reference not containing SVHC above the threshold

## Contractual warranty

Warranty period	18 months
-----------------	-----------

## Dimensions

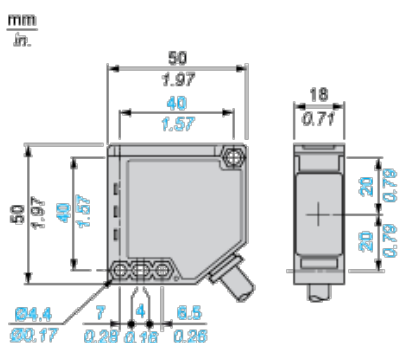

## Wiring Schemes

### Relay Output

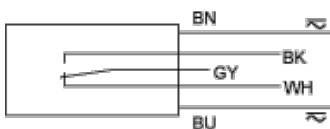

BN : Brown

BU : Blue

BK : Black (NO)

GY : Grey (Relay common)

WH : White (NC)

## Detection Curves

### With Thru-beam Accessory (Thru-beam)

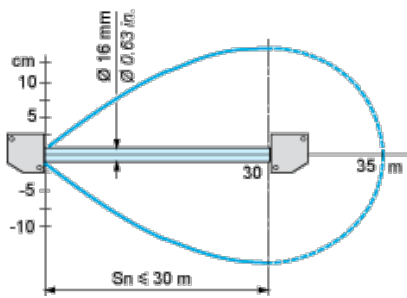

**Without Accessory (Diffuse)**

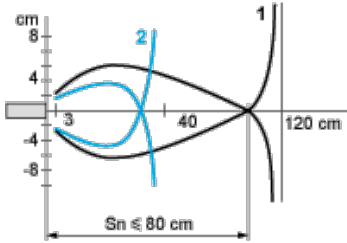

- 1 : White 90%
  - 2 : Grey 18%
- Object 10 x 10 cm

**Without Accessory (Diffuse with background suppression)**

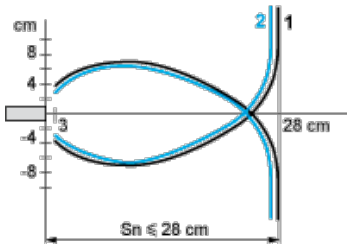

- 1 : White 90%
  - 2 : Grey 18%
- Object 10 x 10 cm

**With reflector (Polarised reflex)**

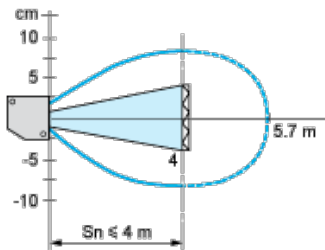

With reflector XUZC50

**Variation of Usable Sensing Distance Su (Without accessory, with adjustable background suppression)**

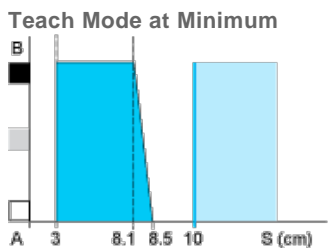

Teach Mode at Maximum

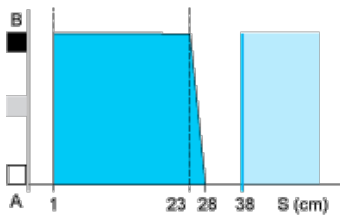

- (1) Black
- (2) Grey
- (3) White
- (4) Sensing range
- (5) Non sensing zone

A-B :Object reflection coefficient

- (1) Black 6%
- (2) Grey 18%
- (3) White 90%
- (4) Sensing range
- (5) Non sensing zone (matt surfaces)